

Oval 7236SD | Water 9 Jet Massage

Product Number: BUDROH9J7236SDFS-A 72" x 36" x 28"



STANDARD & OPTIONAL ACCESSORIES

JETS: 9 Total

- 9 Micro Flow Water Jets

PUMPS

1.25 Hydropower 1-speed Pump

CONTROLS

Air Switch On/Off Control(s)

DRAINS OPTIONAL

- Bath Drain - Pop up: Polished Chrome or Brushed Nickel
- In Floor Drain EZ Fast Connect (optional)

FAUCET INFORMATION

- Floor mount (not included)
- Floor mount verify spout distance
- Optional Pump Access Panel (Highly Recommended)

ADDITIONAL INFORMATION

6 1/2" or more space required to access equipment panel. Tub may also need to be shifted or optional disconnected in some situations.

Access panel equipment design and location may vary based on model. If optional access is not added, tub may not pass inspection and tub will need to be removed for service.

Your qualified installer must water test and run all equipment before leaving your home to ensure proper operation and validate warranty.



TECHNICAL SPECIFICATIONS

Side drain

Pump Location(s): Standard or #2RF

ELECTRICAL REQUIREMENTS

(1) 115v 20AMP GFCI Circuits



Optional Equipment Access Panel

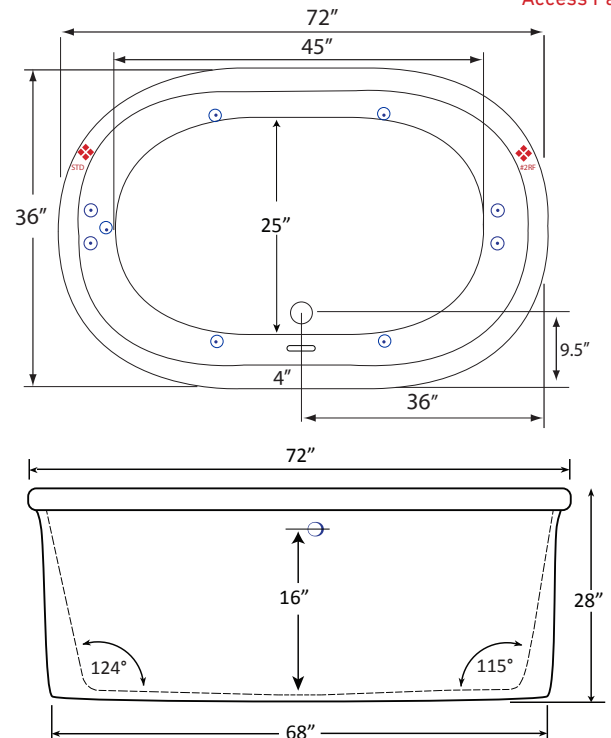

Specifications and features are subject to change without notice and are + .25". All final measurements should be taken from tub on site.

HydroMassage Products LLC • 303-341-1845 • Fax: 303-341-1850 • www.hydromassageproducts.com