



Fantasy FAHP7242 72" x 42" x 27"

PRODUCT NUMBER: FAHP7242  

HYDRO PLATINUM SERIES

Hydro Massage
Your Health ... Our Passion

TECHNICAL SPECIFICATIONS	
Drain	Side drain
Pump Location(s): Select 2	Std. = Standard / Alt LF/RF Optional
Bath Weight (empty)	195 lbs
Gallons to Operate	74-120
ELECTRICAL SPECIFICATIONS	
Motor/Pump	(2) 115v 20AMP GFCI Circuits
Inline Stainless Steel Heater	(1) 115v 20AMP GFCI Circuit





BATHERS: 2	
INSTALLATION	
•	DECK (D)
	UNDER MOUNT (U)
	ALCOVE (A)
	FREESTANDING (F)
	CLAWFOOT (L)
	PEDESTAL (P)

Jet & Control placement may vary



STANDARD FEATURES & ACCESSORIES for HYDRO PLATINUM SERIES BATHS _____

JETS

- 20 Water Jets
- Back Massage System(s) (7 Jets)
- Neck Massage Pillow (2 Jets) 
- Sole Soother Jet(s) 
- Accumassage Back, Neck 
- Ultra Flow Jets 

PUMPS

- Two 3.25 Hydrowave 3-speed Pumps (Side Drain Baths)
- Quiet Pad Anti-Vibration Mounted Pump

HEATERS

- Stainless Steel Electric Heater

CONTROLS

- Air Switch On/Off Control(s) For Chromotherapy Lighting
- 3 Speed Massage: High, Medium or Low

PURITY

- HydroClean Water Purity System
- HydroCleanse

STANDARD ACCESSORIES

- Grab Bar(s) - 1 on Side Drain baths
White, Biscuit, Bone, Brushed Nickel, Polished Chrome
- Chromotherapy Lighting
- Deluxe Cable Drain - White, Biscuit, Bone, Brushed Nickel,
Oil Rubbed Bronze, Polished Chrome
- Deluxe Cushion Pillow on two person baths
- Neck Massage Pillow
- EZ Level Base
- FDA Recipe Non-Toxic Food & Beverage Grade Plumbing (primarily)
- 30 Point Quality Assurance Factory Test

REQUIREMENTS

- Pump Locations: Select 2
- Electrical: three 115v 20AMP GFCI Circuits
- Drain and Grab Bars: Select Color / Finish
- Tub should not be supported by the lip in any way. Level tub & screw or glue EZ Level adjustable legs to sub floor.**
- CUT OUT DIMENSIONS:**
 - OVALS:** A template will be provided
 - RECTANGLES:** Subtract 1" to 1.5" from length & width for hole cut out size

EZ CLEAN CAST ACRYLIC LIMITED LIFETIME WARRANTY 

OPTIONAL FEATURES & ACCESSORIES

(Please type in the box below)

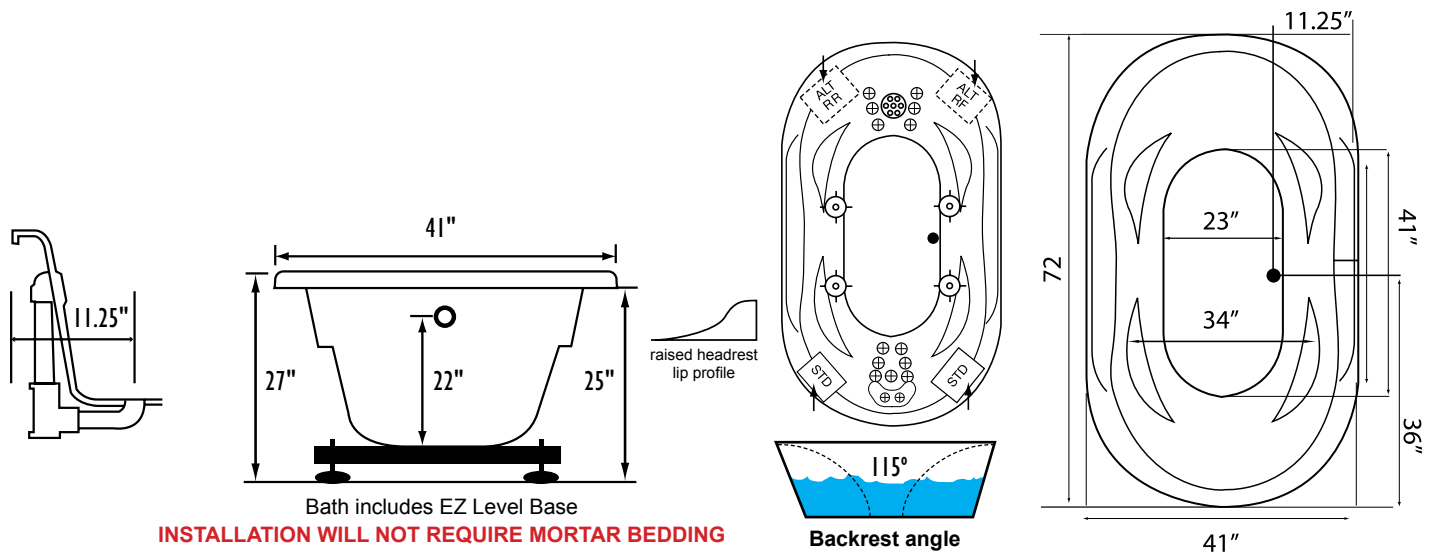

Some standard & most alternate pump locations may stickout past perimeter of the bath 1"-3". NOTE: Graphics may not be to scale. Specifications and features are subject to change without notice and are $\pm .25"$. All final measurements should be taken from tub on site. Access 18"x 18" or larger is required for each pump. Consult your contractor for installation requirements.