

Kimber 6731 | Bathtub Only

Product Number: KITO6731CDFS 67" x 31" x 24"



STANDARD & OPTIONAL ACCESSORIES

DRAINS & OVERFLOWS INFORMATION

- Overflow: Integral Linear: Included- Polished Chrome or Brushed Nickel. **Optional** - White.
- Bath Drain: Pop up: Included- Polished Chrome or Brushed Nickel.
- In Floor Drain EZ Fast Connect (**optional**)

FAUCET INFORMATION

- Floor mount (not included) – verify spout distance

OPTIONAL

- Chromatherapy
- Underwater Light
- Deluxe cushion pillow
- Sushi body cushion pillow
- Cozy heated back rest

Some optional items above will require an electrical circuit and access panel. Not all options available on all models. Check price sheet to verify.



TECHNICAL SPECIFICATIONS

Center drain

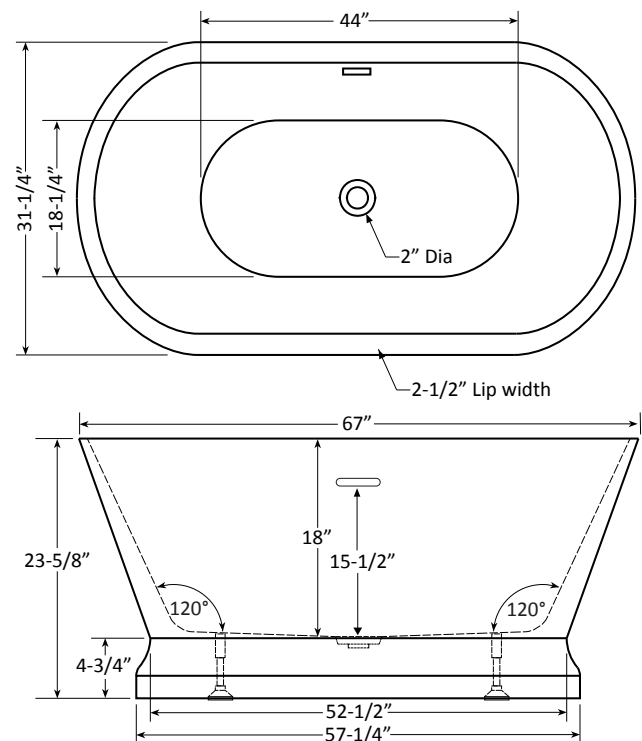

Specifications and features are subject to change without notice and are + .25". All final measurements should be taken from tub on site.
HydroMassage Products LLC • 303-341-1845 • Fax: 303-341-1850 • www.hydromassageproducts.com