



# Serenity SEAG7236 72" x 36" x 21"

PRODUCT NUMBER: SEAG7236  

AIR GOLD SERIES

*Hydro Massage*  
Your Health ... Our Passion

TECHNICAL SPECIFICATIONS	
Drain	End drain
Pump Location(s): Select 1	Std. = Standard / Alt LF/RF Optional
Bath Weight (empty)	160 lbs
Gallons to Operate	54-72
ELECTRICAL SPECIFICATIONS	
Motor/Pump	(1) 115v 20AMP GFCI Circuits

BATHERS: 1	
INSTALLATION	
•	DECK (D)
	UNDER MOUNT (U)
•	ALCOVE (A)
	FREESTANDING (F)
	CLAWFOOT (L)
	PEDESTAL (P)

Jet & Control placement may vary



## STANDARD FEATURES & ACCESSORIES for AIR GOLD SERIES BATHS \_\_\_\_\_

### JETS

18 EZ Clean™ Air Jets on Sidewall **X**

### PUMPS

1.25 Air Power Variable Speed, Pulse & Wave heated Air Pump  
Quiet Pad Anti-Vibration Mounted Pump

### HEATERS

Warm Back Rest Tubing Zone

### CONTROLS

Air Switch On/Off Control(s) for mood lighting  
Variable Speed Air Massage Control  
Automatic Purge & Dry Cycle Control

### PURITY

HydroCleanse

### STANDARD ACCESSORIES

Mood Light  
Lift & Turn Drain - White, Biscuit, Bone, Brushed Nickel,  
Oil Rubbed Bronze, Polished Chrome  
Deluxe Cushion Pillow  
EZ Level Adjustable Legs  
FDA Recipe Non-Toxic Food & Beverage Grade Plumbing (primarily)  
30 Point Quality Assurance Factory Test

### REQUIREMENTS

Pump Locations: Select 1  
Electrical: one 115v 20AMP GFCI Circuits  
Drain: Select Color / Finish

**Tub should not be supported by the lip in any way. Level tub & screw or glue EZ Level adjustable legs to sub floor.**

### CUT OUT DIMENSIONS:

**OVALS:** A template will be provided  
**RECTANGLES:** Subtract 1" to 1.5" from length & width for hole cut out size

**EZ CLEAN CAST ACRYLIC LIMITED LIFETIME WARRANTY** 

## OPTIONAL FEATURES & ACCESSORIES

(Please type in the box below)

- A** **X** HTT® Leg Therapy Air Massage System includes 10 Air Jets on the floor. Optional on Combo Plat and Combo Gold Series
- B** **X** 6 Jet HTT® Back Massage System: N/A on Combo Series-Standard on Plat series
- C**  Warm Back Tubing Zone

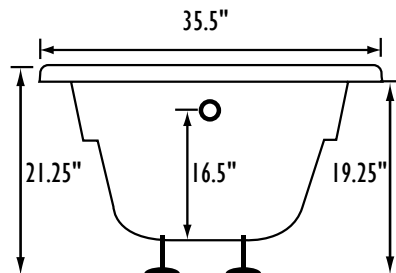
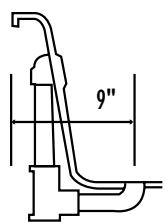

radius corner lip profile

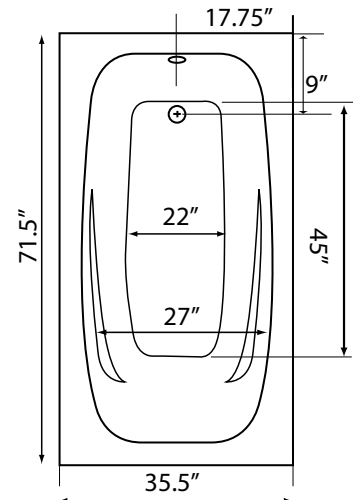
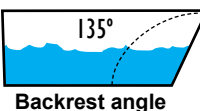
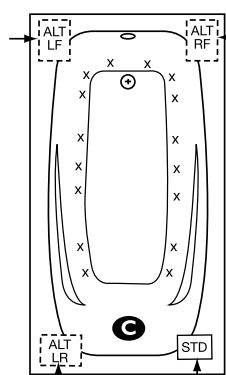

**INSTALLATION WILL NOT REQUIRE MORTAR BEDDING**

Backrest angle

Some standard & most alternate pump locations may stickout past perimeter of the bath 1"-3". NOTE: Graphics may not be to scale. Specifications and features are subject to change without notice and are ± .25". All final measurements should be taken from tub on site. Access 18"x 18" or larger is required for each pump. Consult your contractor for installation requirements.