



Serenity AP9440 94" x 40" x 22"

PRODUCT NUMBER: SEAP9440   

AIR PLATINUM SERIES

Hydro Massage
Your Health ... Our Passion

TECHNICAL SPECIFICATIONS	
Drain	End drain
Pump Location(s): Select 2	Std. = Standard / Alt LF/RF Optional
Bath Weight (empty)	215 lbs
Gallons to Operate	85-110
ELECTRICAL SPECIFICATIONS	
Motor/Pump	(1) 115v 20AMP GFCI Circuits
Whisper Flo Heat System	(2) 115v 20AMP GFCI Circuit

BATHERS: 1	
INSTALLATION	
•	DECK (D)
	UNDER MOUNT (U)
	ALCOVE (A)
	FREESTANDING (F)
	CLAWFOOT (L)
	PEDESTAL (P)

Jet & Control placement may vary



STANDARD FEATURES & ACCESSORIES for AIR PLATINUM SERIES BATHS _____

JETS

34 EZ Clean Air Jets
HTT Leg Therapy Air Massage Jets **X**
HTT Back Therapy Air Massage Jets **X**

PUMPS

1.25 Air Power Variable Speed, Pulse & Wave heated Air Pump
Quiet Pad Anti-Vibration Mounted Pump
WhisperFlo Heat Pump System with Control & Ecobond Foam Insulation
(must select Pump Locations)

HEATERS

Stainless Steel Electric Heater
Warm Back Rest Tubing Zone

CONTROLS

Air Switch On/Off Control(s) for Chromatherapy & Whisper Flo Heat Pump
Variable Speed Air Massage Control
Automatic Purge & Dry Cycle Control

PURITY

HydroClean Water Purity System
HydroCleanse

STANDARD ACCESSORIES

Grab Bar(s) - 2 on End Drain baths - White, Biscuit, Bone, Brushed Nickel, Polished Chrome
Chromatherapy Lighting
Deluxe Cable Drain - White, Biscuit, Bone, Brushed Nickel, Oil Rubbed Bronze, Polished Chrome
Deluxe Cushion Pillow
EZ Level Base
FDA Recipe Non-Toxic Food & Beverage Grade Plumbing (primarily)
30 Point Quality Assurance Factory Test

COLOR

Only Available in White

REQUIREMENTS

Pump Locations: Select 2
Electrical: Three 115v 20AMP GFCI Circuits
Drain and Grab Bars: Select Color / Finish
Tub should not be supported by the lip in any way.
Level tub & screw or glue EZ Level adjustable legs to sub floor.
CUT OUT DIMENSIONS:
OVALS: A template will be provided
RECTANGLES: Subtract 1" to 1.5" from length & width for hole cut out size

EZ CLEAN CAST ACRYLIC LIMITED LIFETIME WARRANTY  **US ANSI**

OPTIONAL FEATURES & ACCESSORIES

(Please type in the box below)

- A** X **HTT® Leg Therapy Air Massage System** includes 10 Air Jets on the floor. Optional on Combo Plat and Combo Gold Series
- B** X **6 Jet HTT® Back Massage System:** N/A on Combo Series-Standard on Plat series
- C**  **Warm Back Tubing Zone**

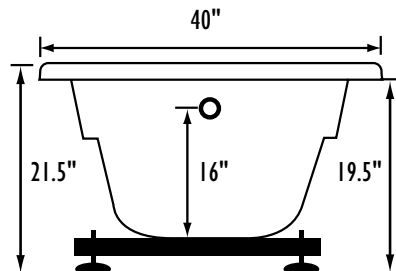
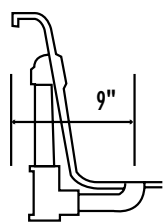

Bath include EZ Level Base

INSTALLATION WILL NOT REQUIRE MORTAR BEDDING

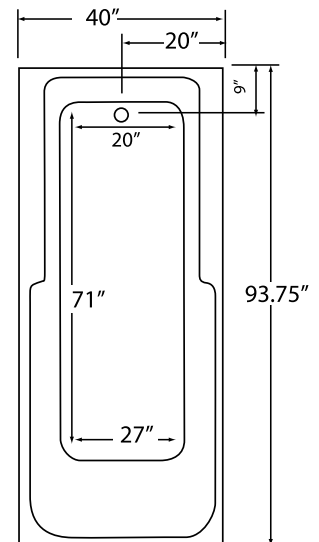
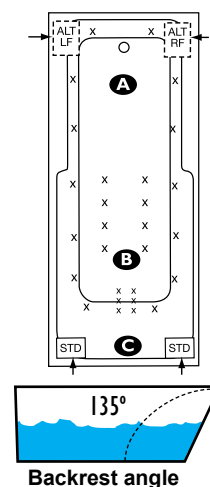

Some standard & most alternate pump locations may stickout past perimeter of the bath 1"-3". NOTE: Graphics may not be to scale. Specifications and features are subject to change without notice and are ± .25". All final measurements should be taken from tub on site. Access 18"x 18" or larger is required for each pump. Consult your contractor for installation requirements.