

# Zen ZCEP7236SD 72" x 36" x 23"

PRODUCT NUMBER: ZCEP7236SD 

## COMBINATION PLATINUM SERIES

*Hydro Massage*  
Your Health ... Our Passion

TECHNICAL SPECIFICATIONS	
Drain	Side drain
Pump Location(s): Select 3	Std. = Standard / Alt LF/RF Optional
Bath Weight (empty)	180 lbs
Gallons to Operate	72-90
ELECTRICAL SPECIFICATIONS	
Motor/Pump	(3) 115v 20AMP GFCI Circuits
Inline Stainless Steel Heater	(1) 115v 20AMP GFCI Circuit





BATHERS: 2	
INSTALLATION	
•	DECK (D)
•	UNDER MOUNT (U)
•	ALCOVE (A)
	FREESTANDING (F)
	CLAWFOOT (L)
	PEDESTAL (P)

Jet & Control placement may vary



### STANDARD FEATURES & ACCESSORIES for COMBINATION PLATINUM SERIES BATHS \_\_\_\_\_

#### JETS

- 42 Air & Water Massage Jets
- Back Massage System(s) (7 Jets)
- Neck Massage Pillow (2 Jets) 
- Sole Soother Jet(s) 
- Accumassage Back & Neck Jets 
- Ultra Flow Jets 
- Classic Air Jets 
- EZ Clean Air Jets (optional) **X**

#### PUMPS

- Two-3.25 Hydropower 3-speed Pumps (Side Drain Tubs)
- 1.25 Air Power Variable Speed, Pulse & Wave heated Air Pump
- Quiet Pad Anti-Vibration Mounted Pump

#### HEATERS

- Stainless Steel Heater
- Warm Back Rest Tubing Zone

#### CONTROLS

- Air Switch On/Off for Chromotherapy Lighting
- Air Switch On/Off with digital Temperature Readout Hydro Pumps
- Electronic Variable Speed Air Massage Control with Automatic Purge & Dry Cycle Control Air Pump
- 3 Speed Massage: High, Medium or Low

#### PURITY

- HydroClean Water Purity System
- HydroCleanse

#### OPTIONAL FEATURES & ACCESSORIES

(Please type in the box below)

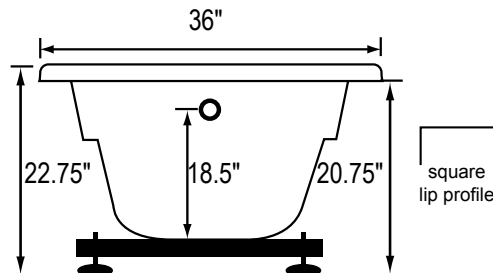
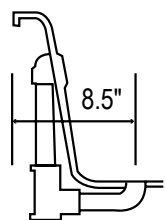

Bath includes EZ Level Base

**INSTALLATION WILL NOT REQUIRE MORTAR BEDDING**

#### STANDARD ACCESSORIES

- Grab Bar(s) - 1 on Side Drain Baths
  - White, Biscuit, Bone, Brushed Nickel, Polished Chrome
- Chromotherapy Lighting
- Deluxe Cable Drain - White, Biscuit, Bone, Brushed Nickel, Oil Rubbed Bronze, Polished Chrome
- Deluxe Cushion Pillow on 2 person baths
- Neck Massage Pillow
- EZ Level Base
- FDA Recipe Non-Toxic Food & Beverage Grade Plumbing (primarily)
- 30 Point Quality Assurance Factory Test

#### REQUIREMENTS

- Pump Locations: Select 3
- Electrical: Four 115v 20AMP GFCI Circuits
- Cable Drain and Grab Bars: Select Color / Finish
- Tub should not be supported by the lip in any way.**
- Level tub & screw or glue EZ Level adjustable legs to sub floor.**
- CUT OUT DIMENSIONS:**
  - OVALS:** A template will be provided
  - RECTANGLES:** Subtract 1" to 1.5" from length & width for hole cut out size

**EZ CLEAN CAST ACRYLIC LIMITED LIFETIME WARRANTY**



- A** **X** **HTT® Leg Therapy Air Massage System** includes 10 Air Jets on the floor. Optional on Combo Plat and Combo Gold Series
- B** **X** **6 Jet HTT® Back Massage System:** N/A on Combo Series-Standard on Plat series
- C**  **Warm Back Tubing Zone**

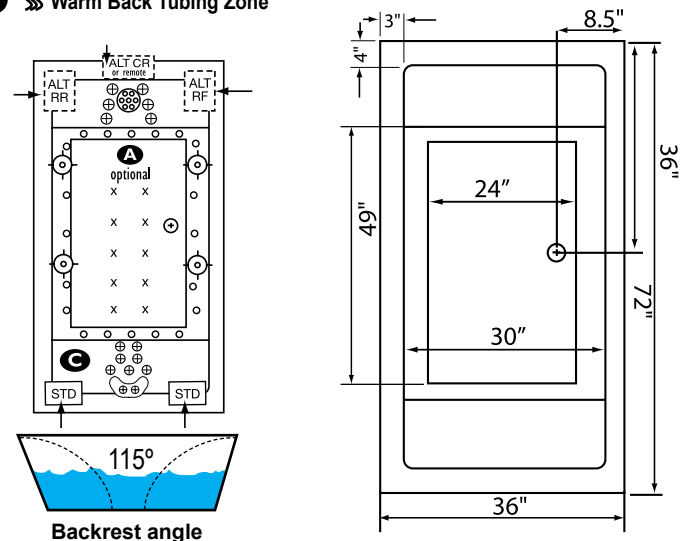

**Some standard & most alternate pump locations may stickout past perimeter of the bath 1"-3". NOTE: Graphics may not be to scale. Specifications and features are subject to change without notice and are ± .25". All final measurements should be taken from tub on site. Access 18"x 18" or larger is required for each pump. Consult your contractor for installation requirements.**